



88126001



International Baccalaureate®  
Baccalauréat International  
Bachillerato Internacional

**BIOLOGY  
HIGHER LEVEL  
PAPER 1**

Friday 16 November 2012 (afternoon)

1 hour

---

**INSTRUCTIONS TO CANDIDATES**

- Do not open this examination paper until instructed to do so.
- Answer all the questions.
- For each question, choose the answer you consider to be the best and indicate your choice on the answer sheet provided.
- The maximum mark for this examination paper is *[40 marks]*.

1. A student completed a study on the height of trees of different ages. The results are shown in the following graph.

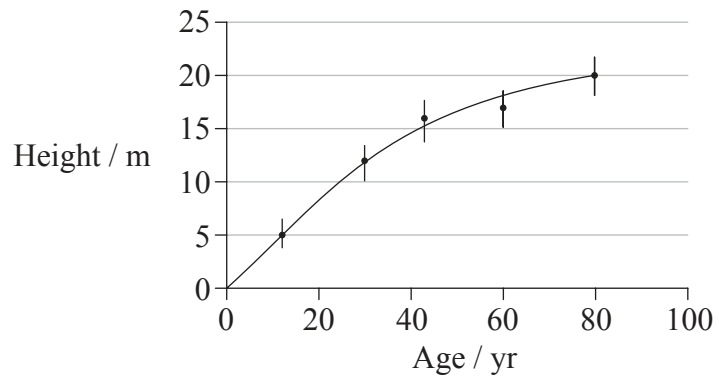

What could the vertical bars represent?

- A. The median height for each age of tree
  - B. The value of  $t$  compared to other species of trees
  - C. Plus one to minus one standard deviation
  - D. The correlation between the height and diameter of the trees
2. What is proportional to a cell's surface area?
- A. Rate of exchange of materials
  - B. Rate of heat production
  - C. Rate of waste production
  - D. Rate of oxygen consumption

3. Which is a difference between prokaryote and eukaryote cells?

	<b>Prokaryote cell</b>	<b>Eukaryote cell</b>
A.	no ribosomes	ribosomes
B.	no region containing DNA	nucleus containing DNA
C.	no flagella	flagella
D.	no mitochondria	mitochondria

4. The following events occur in mitosis.

X: Attachment of spindle microtubules to centromeres

Y: Movement of sister chromatids to opposite poles

Z: Supercoiling of chromosomes

What is the correct sequence of events?

A. X → Z → Y

B. X → Y → Z

C. Z → X → Y

D. Z → Y → X

5. Which structure represents a fatty acid?

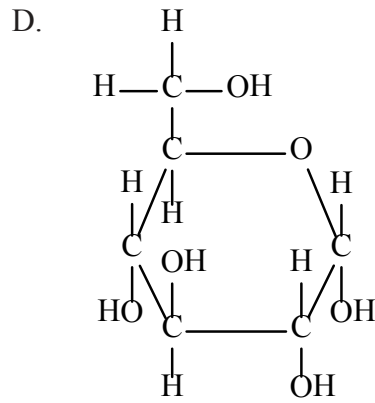
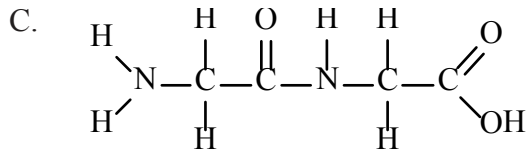
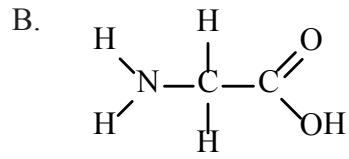
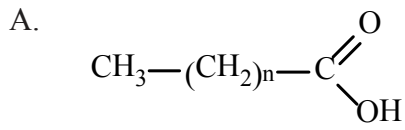

Questions 6 and 7 refer to the following DNA diagram.

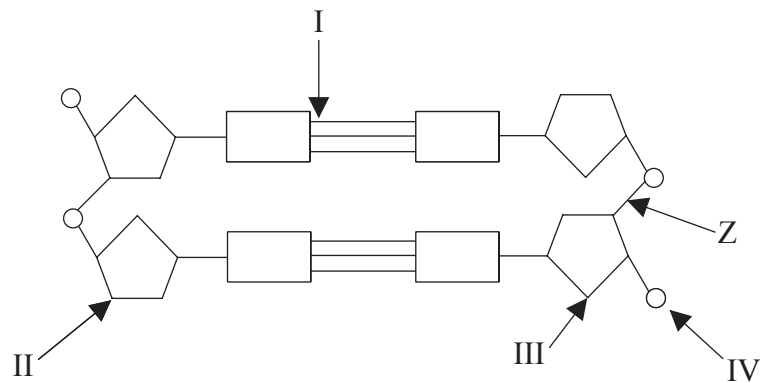

6. Which points to the 3' end of a strand of DNA?

- A. I
- B. II
- C. III
- D. IV

7. What type of bond does Z represent?
- A. Covalent bond
  - B. Hydrogen bond
  - C. Peptide bond
  - D. Semi-conservative bond
8. What is the energy absorbed by chlorophyll used directly for in plants?
- I. To produce ATP
  - II. To split water
  - III. To fix CO<sub>2</sub>
- A. I only
  - B. III only
  - C. I and II only
  - D. II and III only
9. What stage of meiosis is shown in the micrograph?



[Source: [www.vcbio.science.ru.nl/en/virtuallessons](http://www.vcbio.science.ru.nl/en/virtuallessons)  
Used with permission.]

- A. Prophase I
- B. Metaphase II
- C. Anaphase II
- D. Telophase I

10. What commonly causes Down syndrome in humans?
- A. Non-disjunction
  - B. Base substitution
  - C. Amniocentesis
  - D. Gene mutation
11. When genes are transferred between species, the amino acid sequence of the polypeptide translated from them is unchanged. Why is this so?
- A. All organisms use ribosomes for protein synthesis.
  - B. DNA replication is semi-conservative.
  - C. The enzymes used are substrate specific.
  - D. The genetic code is universal.
12. A biologist exploring an uninhabited island came across an unknown plant. She made the following notes:
- grows in a damp and shady corner of the island
  - has large feathery leaves with spore cases (sporangia) arranged on the underside
  - young leaves are tightly rolled up
  - has roots.

In what phylum should she classify this plant?

- A. Angiospermophyta
- B. Bryophyta
- C. Coniferophyta
- D. Filicinophyta

13. The diagram shows a pyramid of energy for a wetland environment. What units would be appropriate for the values shown?

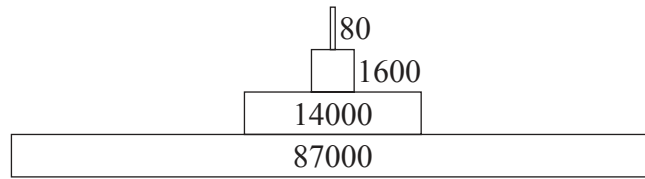

- A.  $\text{kg yr}^{-1}$
  - B.  $\text{kJ m}^{-2} \text{yr}^{-1}$
  - C.  $\text{J m}^{-2}$
  - D.  $\text{mg dry mass m}^{-3}$
14. The diagram shows the carbon cycle. Which letter indicates respiration?

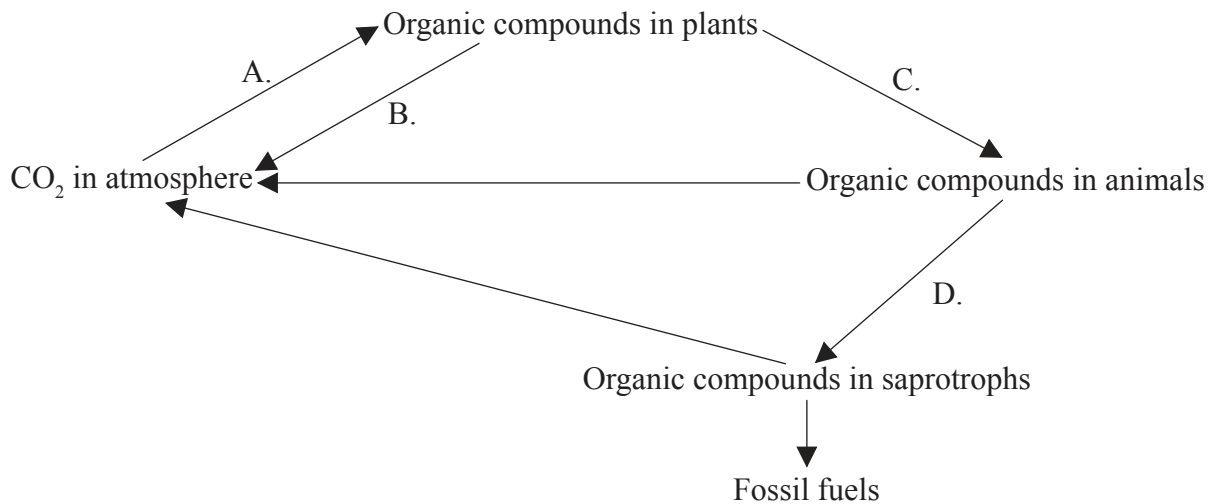

Questions 15 and 16 refer to the following diagram which is part of a food web for a freshwater habitat.

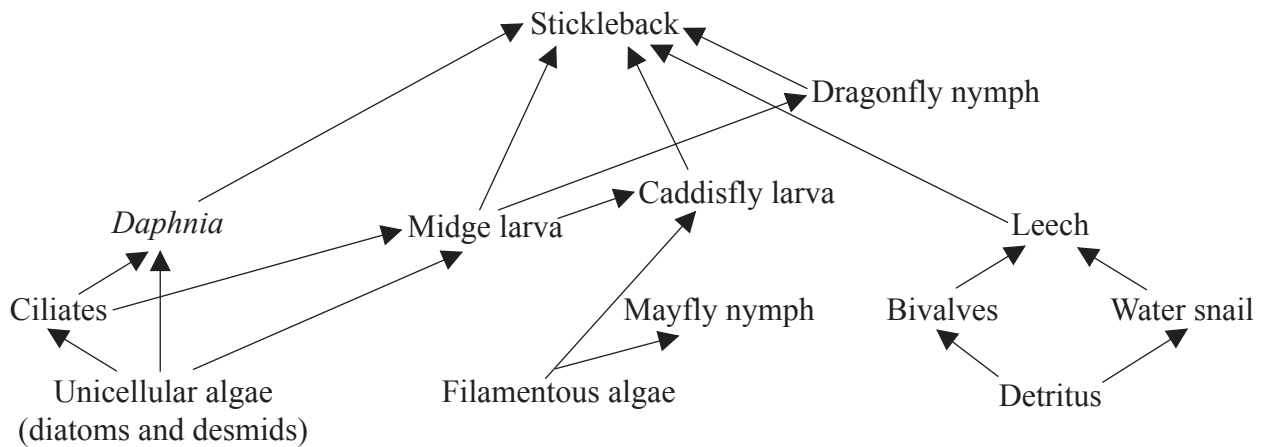

15. What is the mode of nutrition of midge larva?
- A. Autotroph
  - B. Detritivore
  - C. Heterotroph
  - D. Saprotroph
16. Which represents a correct food chain from this web?
- A. stickleback → midge larva → unicellular algae
  - B. ciliates → *Daphnia* → stickleback → dragonfly nymph
  - C. diatom → midge larva → caddisfly larva → stickleback
  - D. filamentous algae → mayfly nymph → leech → stickleback



17. Which numbers represent exponential growth in a population of water fleas introduced to a new culture medium?

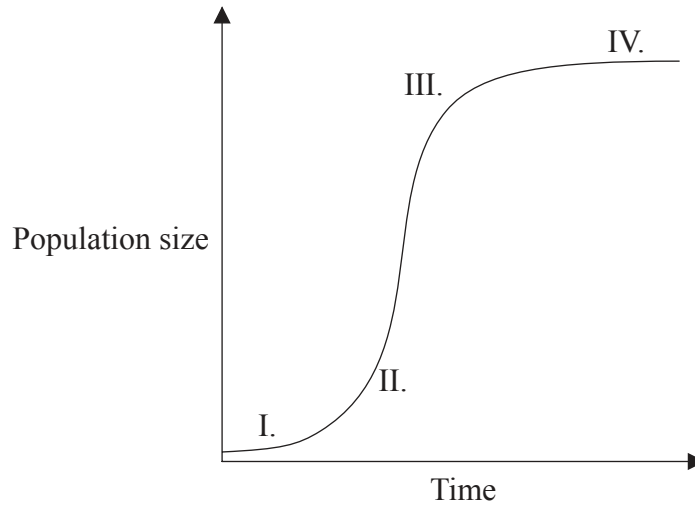

- A. I and II
  - B. II and III
  - C. I, II and III
  - D. II, III and IV
18. What is the direction of flow of oxygenated blood during a heartbeat?
- A. left atrium → semilunar/aortic valve → left ventricle → pulmonary vein
  - B. pulmonary vein → left atrium → left ventricle → semilunar/aortic valve
  - C. left atrium → left ventricle → semilunar/aortic valve → pulmonary vein
  - D. pulmonary vein → left atrium → semilunar/aortic valve → left ventricle
19. What are antibodies?
- A. Organisms or viruses that cause disease
  - B. Drugs used to treat bacterial diseases
  - C. Substances the body recognizes as foreign
  - D. Proteins that bind to foreign substances

20. The diagram shows events at a synapse.

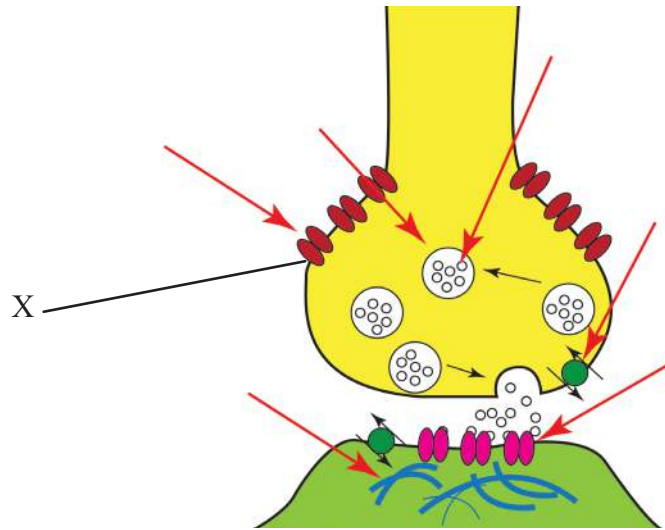

[Source: Adapted from: [http://en.wikipedia.org/wiki/File:Synapse\\_Illustration\\_unlabeled.svg](http://en.wikipedia.org/wiki/File:Synapse_Illustration_unlabeled.svg)]

What is happening at the point labelled X?

- A. Neurotransmitter binding
  - B. Ca<sup>2+</sup> diffusing
  - C. Neurotransmitter moving across synapse
  - D. Na<sup>2+</sup> binding
21. What is a feature of type I diabetes but not type II diabetes?
- A. Target cells become insensitive to insulin.
  - B.  $\beta$  cells do not produce sufficient insulin.
  - C. Type I diabetes can be controlled through a low carbohydrate diet.
  - D.  $\alpha$  cells produce excess insulin.

22. The concentration of which hormone peaks sharply triggering ovulation?

- A. FSH
- B. LH
- C. Estrogen
- D. Progesterone

23. The diagram shows a section through the male reproductive system. Which structure represents the prostate gland?

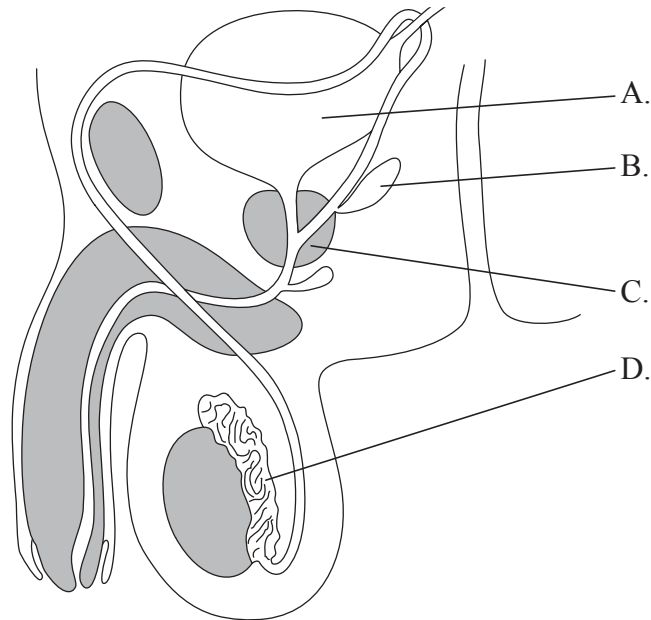

24. The diagram is a three-dimensional molecular model of a protein.



[Source: Reprinted by permission from Macmillan Publishers Ltd: Nature, Toshimitsu Kawate, Jennifer Carlisle Michel, William T. Birdsong & Eric Gouaux, 'Crystal structure of the ATP-gated P2X4 ion channel in the closed state', 460, pp 592-598, © 2009. www.nature.com.]

Which bonds stabilize the shape of the area labelled X?

- A. Covalent bonds between adjacent amino acids
  - B. Hydrogen bonds between N-H and C=O groups of amino acids
  - C. Hydrophobic interactions between R groups of amino acids
  - D. Disulphide bridges between cysteine molecules
25. The following graph shows energy changes with and without enzymes during a chemical reaction. Which letter represents the activation energy required to carry out this reaction without an enzyme catalyst?

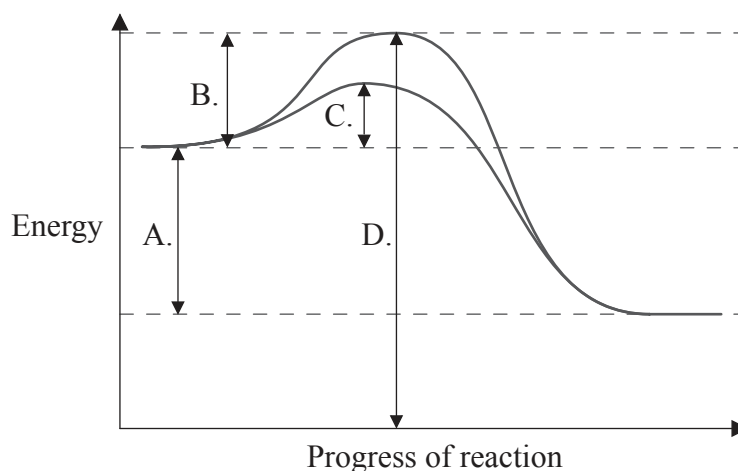

26. The diagram represents an allosteric enzyme.

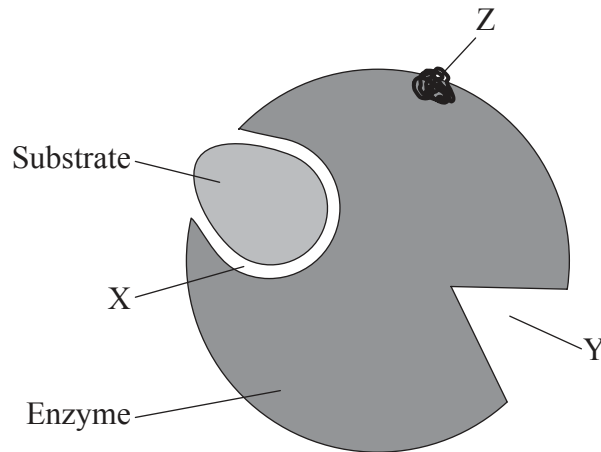

© International Baccalaureate Organization, 2013

Where would the following inhibitors be most likely to bind?

	<b>End-product inhibitor</b>	<b>Competitive inhibitor</b>	<b>Non-competitive inhibitor</b>
A.	X	Y	Z
B.	Y	Z	X
C.	X	Z	Y
D.	Y	X	Z

27. The antisense strand of a DNA molecule has the sequence TACCCGATC. What would be the resulting mRNA strand sequence?

- A. TACCCGATC
- B. ATGGGCTAG
- C. UACCCGAUC
- D. AUGGGCUAG

28. What occurs during cyclic photophosphorylation?
- A. Acceptance of high energy electrons by NADP to form NADPH
  - B. Reduction of glycerate-3-phosphate (GP) to triose phosphate (TP)
  - C. Use of energy from ATP to regenerate ribulose biphosphate (RuBP)
  - D. Production of ATP using energy from excited electrons from photosystem I

29. The diagram represents components of the cristae in mitochondria. Which arrow indicates how protons ( $H^+$ ) move to generate ATP directly?

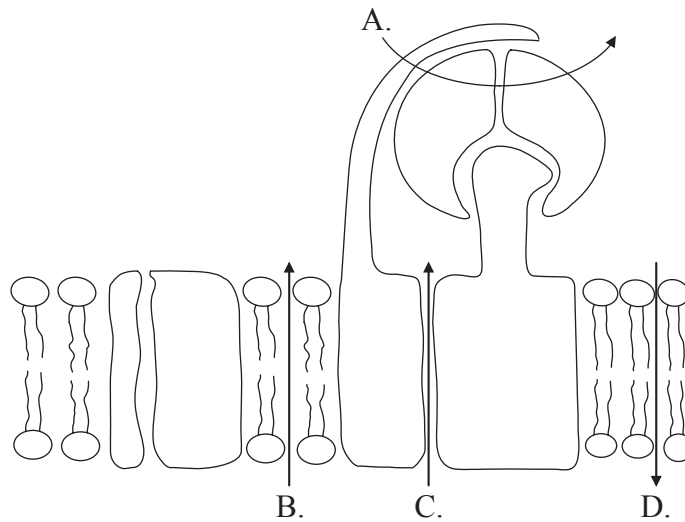

© International Baccalaureate Organization, 2013

30. In the following diagram of a metabolic pathway, which letter represents acetyl CoA?

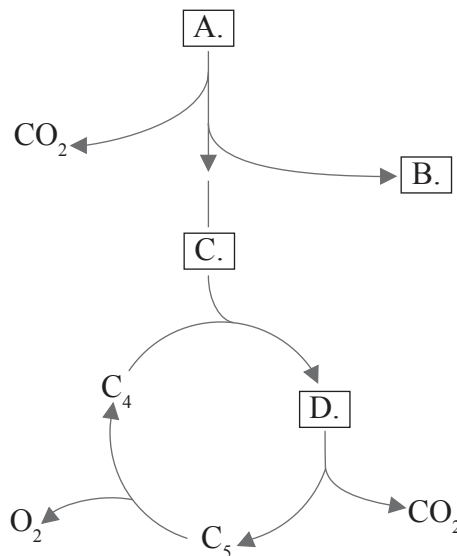

31. The diagram shows a section through a typical dicotyledonous leaf.

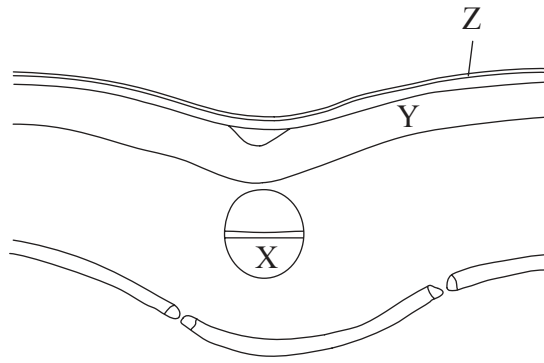

© International Baccalaureate Organization, 2013

Which correctly identifies the main functions of the structures labelled X, Y and Z?

	X	Y	Z
A.	support	gas exchange	photosynthesis
B.	transport products of photosynthesis	photosynthesis	water conservation
C.	gas exchange	water conservation	light absorption
D.	transport water	support	gas exchange

32. What is a role of gibberellin produced in the cotyledon of a dicotyledonous seed?

- A. To open the micropyle to allow water absorption
- B. To catalyse the breakdown of starch to maltose
- C. To provide energy needed for growth
- D. To stimulate production of amylase

33. What is the role of  $P_{ft}$  in plants?

- A. To promote flowering in long-day plants
- B. To promote flowering in short-day plants
- C. To inhibit flowering in long-day plants
- D. To inhibit flowering in both long-day plants and short-day plants

34. In humans, wavy hair is dominant to straight hair and free ear lobes are dominant to fixed ear lobes. A man and a woman are heterozygous for both characteristics. What is the probability that their first child will have straight hair and fixed ear lobes?

- A. 0
- B. 1/16
- C. 3/16
- D. 9/16

35. Flower colour and pollen grain shape are linked genes in sweet peas. Purple (F) is dominant to red (f) flower colour and long pollen grains (L) are dominant to round pollen grains (l).

If the parental genotype is  $\frac{FL}{f l}$ , what would be the recombinant chromosomes in the gametes?

- A. FL and fl
- B. Ff and Ll
- C. F l and f L
- D. FF and ll

36. Formation of a blood clot by damaged tissue involves the series of steps outlined in the following diagram. Which letter represents a soluble globular protein that will be converted into an insoluble protein during clot formation?

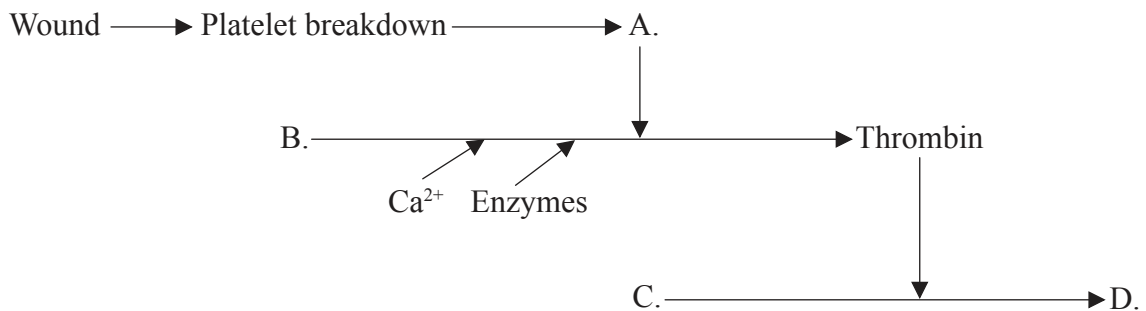



37. What first happens to a B lymphocyte when it becomes activated?
- A. It divides by mitosis producing a clone of cells.
  - B. It begins transcription and produces antigens.
  - C. It differentiates into memory cells.
  - D. It produces antibodies using its extensive rough endoplasmic reticulum (rER).
38. During muscle contraction, what is the role of calcium ions ( $\text{Ca}^{2+}$ ) which are released from the sarcoplasmic reticulum?
- A. To cause ATP hydrolysis on myosin filaments
  - B. To bind to both actin and myosin filaments forming a cross-bridge
  - C. To cause the cross-bridge to detach itself and start a new cycle
  - D. To cause binding sites on the actin filaments to be uncovered
39. What is the function of the knee joint?
- A. It permits movement in one plane.
  - B. It allows bones to glide over each other.
  - C. It facilitates movement in all planes.
  - D. It allows a wide range of movement.

40. What is a difference between spermatogenesis and oogenesis?

	<b>Spermatogenesis</b>	<b>Oogenesis</b>
A.	begins at puberty	begins at birth
B.	takes approximately 70 days	takes approximately 28 days
C.	does not require FSH	requires FSH
D.	produces four gametes per meiosis	produces one gamete per meiosis

---